

Report on the investigation of  
a lifeboat accident on

**mv *Galateia***

Seaforth Docks, Liverpool

26 January 2002

Marine Accident Investigation Branch  
First Floor  
Carlton House  
Carlton Place  
Southampton  
United Kingdom  
SO15 2DZ

**Report No 25/2002**  
**July 2002**

**Extract from**  
**The Merchant Shipping**  
**(Accident Reporting and Investigation)**  
**Regulations 1999**

The fundamental purpose of investigating an accident under these Regulations is to determine its circumstances and the cause with the aim of improving the safety of life at sea and the avoidance of accidents in the future. It is not the purpose to apportion liability, nor, except so far as is necessary to achieve the fundamental purpose, to apportion blame.

# CONTENTS

	Page
<b>GLOSSARY OF ABBREVIATIONS AND ACRONYMS</b>	
<b>SYNOPSIS</b>	<b>1</b>
<b>SECTION 1 - FACTUAL INFORMATION</b>	<b>3</b>
1.1 Particulars of <i>Galateia</i> and accident	3
1.2 Background	4
1.3 Narrative	5
1.4 Lifeboat details	8
1.5 The ISM code	12
<b>SECTION 2 - ANALYSIS</b>	<b>13</b>
2.1 Aim	13
2.2 Cause of involuntary release	13
2.3 Instruction and training	17
2.4 The ISM Code and change of ownership/flag	19
2.5 Design of the release gear	20
2.6 Port Authority's reporting procedures	21
2.7 Accident response	21
2.8 Maintenance records and the ISM Code	22
2.9 Previous investigations by the MAIB	22
<b>SECTION 3 - CONCLUSIONS</b>	<b>23</b>
3.1 Cause and contributing factors	23
3.2 Other findings	23
<b>SECTION 4 - RECOMMENDATIONS</b>	<b>24</b>
Annex 1 General photographs	
Annex 2 Copy of original lifeboat release gear instructions issued to vessel as part of the delivery documentation, August 1993.	
Annex 3. Copy of Release Gear Safety Instructions issued to all owners by <i>Shigi Shipbuilding Co Ltd</i> on 28 August 1997.	

## **GLOSSARY OF ABBREVIATIONS AND ACRONYMS**

AB	:	Able Seaman
ABS	:	American Bureau of Shipping
ACL	:	Atlantic Container Line
D.O.C.	:	Document of Compliance
IMO	:	International Maritime Organization
ISM	:	International Safety Management
RIB	:	Rigid Inflatable Boat
SMS	:	Safety Management System
VTS	:	Vessel Traffic Services
Davits	:	Support structure for attaching lifeboat lifting gear
Falls	:	Ropes used with blocks for lowering/hoisting lifeboats
LSA Code	:	International Life Saving Appliance Code
SOLAS 74	:	Safety of Life at Sea 1974

## SYNOPSIS



At about 1055 local time on Saturday 26 January 2002, while in the process of changing ownership and flag in Seaforth Dock, Liverpool, the port lifeboat of the bulk carrier mv *Galateia* fell 19 metres from the davits into the basin waters. Three crewmen who were on board at the time suffered various injuries, one a serious head injury.

The Marine Accident Investigation Branch (MAIB) was notified of the accident that day and the Bahamas Authorities (as the Flag State) were told that the MAIB would investigate.

The vessel had been sold to new owners and, as part of the handover procedure, the new owner's master and chief engineer had joined the vessel on 12 December in New Orleans for the trip to Liverpool. *Galateia* arrived on 8 January, but did not complete discharge until 17 January. The old crew left and the majority of the new crew joined on Friday 25 January, the day before the accident.

It had been arranged that a Classification Society surveyor would be on board the next day to carry out a safety audit so that an Interim Safety Management Certificate could be issued in accordance with the ISM Code. At 1030, when the surveyor required a lifeboat drill to be carried out, the master, together with the chief officer and four other crew members, boarded the port lifeboat. The master explained where the controls were, how they worked and then told the chief officer to carry out the drill. The lifeboat was lowered to the water, disengaged from the falls, the engine tested successfully and the falls reconnected. The lifeboat was then raised to the embarkation deck. Two of the crew left, leaving the remaining three to complete securing the lifeboat in the davits. Just as the chief officer moved the release gear operating handle into the stow position, both hooks opened and the lifeboat fell, striking the deck as it went. It landed in a partially capsized position with one of the entrance doors underwater. The chief officer and an AB suffered bruising, while the other AB had serious head injuries and was unconscious underwater for a time.

A docks crane driver who witnessed the accident, told the Port Authorities, who then brought in the police and ambulance services, and organised tugs and a small craft to effect a rescue. An ACL vessel, berthed opposite, launched one of her lifeboats and carried out a rescue, eventually bringing the injured parties to the quayside where paramedics attended them before they were taken to hospital.

The crewman who suffered head injuries was in intensive care for about three weeks, but recovered after a few weeks' convalescence ashore.

The cause of the accident was the crew's lack of knowledge of the lifeboat system, and failing to engage a locking pin. Contributing factors were insufficient time for familiarisation, and senior officers failing to read the safety manuals.

Recommendations relate to the provision of operating guidance notes, instruction in lifeboat release mechanisms, and the retention of maintenance records on vessels which change ownership.



Port Authority launch alongside assisting in righting the lifeboat



The partially capsized lifeboat - the falls had been lowered in preparation for righting the lifeboat

## **SECTION 1 - FACTUAL INFORMATION**

### **1.1 PARTICULARS OF GALATEIA AND ACCIDENT**

#### **Vessel details**

Registered owner : Angrian Enterprises Ltd,  
80 Broad Street, Monrovia, Liberia

Manager(s) : E Nomikos Corporation,  
4-6 Efplias Str, Piraeus 185 37 Greece

Port of registry : Nassau

Flag : Bahamas

Type : Bulk carrier

Built : Hatachi Zosen, Maizuru, Japan in 1993

Classification society : ABS

Construction : Steel

Length overall : 223.70 metres

Gross tonnage : 38,131

Engine power : 9127 kW (12,240 PS) @ 102 rpm

Service speed : Ballast about 14.5 kts, loaded about 14.0 kts

Other relevant info : Single screw, motor driven.

#### **Accident details**

Accidental disengagement of lifeboat from davits.

Time and date : About 1050, Saturday 26 January 2002

Location of incident : Seaforth Docks, Liverpool

Persons on board : Crew of 24

Injuries/fatalities : Three injured, one with serious head injuries,  
the others bruising.

Damage : Minor damage to lifeboat's hull and rudder.

## 1.2 BACKGROUND

- 1.2.1 *Galateia* had recently been sold by her Greek owners to a company registered in Liberia. As part of the sale agreement, the new owner's master and chief engineer travelled on the vessel during the passage from New Orleans to the UK where the handover took place. The new owner anticipated that such an arrangement would allow both master and chief engineer to familiarise themselves with the vessel and her equipment during the voyage. This familiarisation period lasted from 12 December 2001 through to 25 January 2002.

As is the normal practice in many sale agreements, all documents other than the ship's plans were removed from the vessel when she arrived in Liverpool as part of the handover. These included all previous maintenance records and other machinery history details. The documentation relating to the vessel's International Safety Management Code (ISM) was also removed, as this reflected the previous owner's operating policy and practices.

- 1.2.2 Although the master had access to the plans etc, and familiarised himself with the bridge equipment and the vessel's handling characteristics, he was unable to learn much about the lifeboats and their release equipment. Neither he nor the chief engineer were familiar with this type of release gear, and had repeatedly asked the current master for a demonstration as to how the boats operated.

It was not until 15 January 2002 that the current master agreed to show the master how the lifeboat launching equipment worked. During this demonstration, nobody was allowed in the boat and it was lowered to the water level but not released from the falls. It was then lifted back up again into the davits and its storage position. This was the only demonstration given. It was explained that before operating the release gear, the "safety" pin by the handle needed to be removed. This allowed the handle to be moved into the upright position ready for operation of the release gear. No mention was made of any other safety pin. Although the master climbed into one of the lifeboats during the voyage back to the UK, and studied the various engine controls etc, he failed to read the release instructions pasted on the engine casing and boat canopy. Neither did he read the detailed release and re-engagement instructions for the lifeboat, which formed part of the safety manual on board.

*Galateia* arrived in Liverpool on 8 January 2002, and a part-discharge took place the following day. For commercial reasons, discharge was then stopped and did not resume until the following week, with completion on 17 January. Most of the crew left the vessel on 23 January, but the master, mate, second mate, and second engineer left two days later. At the same time, the original owners removed all maintenance records, operational notes (other than those for the bridge equipment), and the ISM books. During this period, the new owner's managing superintendent arrived to supervise the changeover and the installation of the new crew.

The new owner's chief officer and other officers arrived in Liverpool on Thursday 24 and boarded the vessel that day. The remainder of the crew boarded the following day.

### 1.3 NARRATIVE

- 1.3.1 On arrival, the new crew started work and familiarised themselves with *Galateia's* layout and her equipment. Since she was undergoing a change of name, flag, and ownership, it had been arranged that an ABS surveyor would board on the Saturday to undertake the necessary surveys.

While the chief and second officers were organising the crew, and checking that preparations for the surveys were in hand, the third officer was engaged in changing the vessel's name on all the lifejackets. The master had told the chief officer that the surveyor would need to see a lifeboat drill on Saturday, but could not say when. The second officer, who expected to form part of the lifeboat crew, and who was not familiar with this type of release gear, took the trouble to read the instructions contained in the safety manual during Friday evening. As far as is known, he was the only one to do so.

- 1.3.2 On Saturday morning at about 0830, the chief officer went with the ABS surveyor to check holds Nos 1 & 4. This continued until about 1015 when, after a coffee break, the surveyor decided that a lifeboat drill would be carried out at 1030. As this was the first practice, and only the master had any experience of how the system worked, he arranged for the chief officer, second officer, third officer, third engineer, electrician, and an AB to join him in the port lifeboat. The master showed the chief officer where the release gear was and how it worked, how the engine was started, and where the cooling water valves and batteries were. The master then climbed out of the lifeboat and left the crew of five on board to carry out the drill, while he remained on the boat deck to operate the lowering and raising system. Lifejackets were not worn, as the ship's new name was still being stencilled on them, and many were not dry.

The chief officer carried a hand-held VHF set for conversing with the master, but found that, because of engine and wind noise, it was not very effective. He therefore communicated with the master using hand signals out of the lifeboat hatch. With all the crew in their places and strapped in, the lifeboat engine was started and the master partially released the winch brake. This allowed the lifeboat to descend at a controlled speed under gravity. When it was about one metre from the water, the lifeboat was stopped and a signal given by the master to the chief officer to operate the release mechanism. The chief officer removed the small safety pin locking the handle in the horizontal position, lifted it up into the vertical position, and allowed the loose sleeve to drop down over the hinge. With the handle now locked, he pulled the handle aft, releasing both forward and aft falls simultaneously, causing the boat to drop into the water.

- 1.3.3 With the fore and aft painters still secured, the engine controls were operated to move the lifeboat forward and astern. This demonstrated to the ABS surveyor that the controls worked, and that the crew knew how to operate them. With the surveyor satisfied, the chief officer was instructed to reconnect the falls in preparation for retrieving the lifeboat. The AB working out of the forward hatch secured the forward falls, while the third officer, out of the aft hatch, secured the aft falls. With both sets of falls held on to their respective hooks, the chief officer pushed the handle forward to lock the hooks in place. When both the AB and the third officer confirmed that the falls were fully engaged and locked, the chief officer signalled the master to start hoisting. During hoisting the chief officer held the release handle in the forward position.

When the lifeboat was at the embarkation deck, the second officer and the electrician stepped out of the boat to assist in securing the lifeboat in the davits. On the deck, the bosun was engaged in manually winching the lifeboat back into the davit stowage position, while the master was making ready to put the safety hooks on to the falls. Inside the lifeboat, the third officer was on the port side aft, while the AB was still forward. The chief officer was standing and/or sitting by the release mechanism on the starboard side of the engine and control console. With the lifeboat apparently home in the davits, the chief officer, who had been holding the operating mechanism in the upright position while the lifeboat was being raised, lifted the loose sleeve and folded the handle down in the aft position before engaging the safety pin.

- 1.3.4 As the chief officer folded the handle down, and moved to engage the safety pin, the release gear operated and both hooks released simultaneously. The lifeboat fell away, hit the edge of the boat deck, and fell down the port side of the ship into the water; a distance of about 19 metres. The painter was still attached, and it held the lifeboat against the ship's side. On hitting the water, the lifeboat capsized and then stabilised, floating on its starboard side, partially submerged at the stern and with the port side of the canopy underwater. The lifeboat had flooded up to about one metre in depth. Both chief and third officers suffered bruising and shock, but managed to climb out of the canopy hatch on to the lifeboat shell. As they did so, somebody on *Galateia's* deck shouted down to enquire about the AB who had not yet been seen.

The chief officer went back into the lifeboat immediately, and found the AB unconscious, face-down in the water. It took two or three minutes to free him and between them, the chief and third officer managed to get him up by the open hatch. By this time, a rope ladder had been lowered down the ship's side, and the bosun plus two ABs climbed down to assist.

When the lifeboat fell away, the master threw a lifebuoy down to it, mobilised the crew into organising a rescue attempt, and then called the duty docking master to tell him of the accident.

- 1.3.5 The ACL vessel, *Atlantic Companion*, was on the opposite side of the basin, on the container berth. While the lifeboat exercise was being carried out on *Galateia*, one of the gantry crane drivers involved in loading *Atlantic Companion*, was watching it. Immediately he saw the lifeboat drop, he used his cab radio to call the terminal's shift manager to tell him of the accident. The shift manager called the dock police, the duty dockmaster, and the ACL vessel immediately, asking them if they would help in the rescue.

The dock police alerted ambulance control which in turn told the coastguard. VTS were not contacted by the vessel, but were told of the accident by somebody at the grain terminal at about 1055. They, in turn, also spoke to the duty dockmaster. As a direct result of the shift manager's radio call, *Atlantic Companion's* master called VTS and asked if they were aware of the accident. At 1108, on being told that they were, but that the tug would take at least 10 minutes to arrive, the master offered to launch his lifeboat and assist in the rescue. This offer was gratefully received, and shortly afterwards the rescue lifeboat was fully crewed and in the water. At 1116, the first of two tugs appeared on scene, followed at 1118 by *Atlantic Companion's* lifeboat. As the tugs were rather large and unwieldy it was left to the rescue lifeboat to go alongside and assist in the rescue.

- 1.3.6 Once it was alongside the lifeboat, all three injured persons were transferred to the rescue boat, together with two of *Galateia's* crew. The bosun returned onboard *Galateia* via the rope ladder. The rescue lifeboat's coxswain used the radio to tell *Atlantic Companion's* master that two people had been injured, one badly; the latter lapsing in and out of consciousness. The master advised VTS of the situation. They confirmed that ambulances, together with paramedics, were ready and waiting at the steps at the end of the basin.

By 1124, the transfer of the injured crew had been completed, and the rescue lifeboat left the scene for the steps at the end of the basin, arriving there some five minutes later. The paramedics treated the casualties and, by 1137, they were removed ashore to the waiting ambulances and taken to the local hospital. The two crewmen from *Galateia*, who had remained with the casualties during the rescue, walked back to the vessel. *Atlantic Companion's* rescue lifeboat motored back, and by 1200 she was safely secured on board.

- 1.3.7 The damaged lifeboat remained alongside *Galateia* in the semi-capsized position until an open boat from the port authorities arrived at 1146 to assist in the recovery. The davits were winched out, and the lifeboat falls lowered ready to recover the lifeboat. By using one of the falls, *Galateia's* crew, with help from the port boat, managed to lift and right the lifeboat. Once in this position the falls were hooked on, and by 1209 the lifeboat had been lifted clear of the water. The internal water was then allowed to drain out before the lifeboat was hoisted up back into the davit stowage position. This was achieved by 1234.

An examination of the lifeboat showed that the rudder, propeller guard ring and skeg were damaged, with scrape marks and two hull penetrations; one on the port side and one on the starboard side. Additional hull damage may become evident during detailed examination at the repair yard. Some damage was also present on the aft end of the canopy together with apparently minor damage to internal fittings.

#### 1.4 LIFEBOAT DETAILS

1.4.1 The lifeboat, one of two fitted on *Galateia*, was designed and built by Shigi Shipbuilding Co Ltd, Osaka, Japan and was installed on a Hitachi Zosen built vessel called *Gortys* in 1993. At the time of the accident, the vessel was just in the process of changing her name to *Galateia*. The lifeboat details are as follows:

Model No	:	SZ-65BR
JG Type Approval	:	No 3308
Description	:	FRP Totally Enclosed Lifeboat
Dimensions	:	6.50m x 2.60m x 1.10m
Capacity	:	30 persons
Propulsion	:	Engine driven, battery start.

The Hellenic Republic issued the vessel with a Cargo Ship Safety Equipment Certificate after a survey was carried out on its behalf by an ABS surveyor in Jiangyin, China on 1 July 2001. Attached to that certificate is "Form E", showing a record of equipment for compliance with the International Convention for SOLAS 1974 as amended in 1988. This form was issued on 26 September 1995 by ABS in Osaka, Japan.

A further certificate was issued on 1 July 2001 at Jiangyin, China by ABS in respect of a survey that was carried out while the vessel was afloat for a report on:

*Compliance with periodic servicing of lifeboat launching appliances and on-load releasing gear.*

The report confirmed that the vessel had complied with Chapter III, Regulations 20.11.1. and 20.11.2 of SOLAS 1974/1996.

1.4.2 The instructions for operating the release gear in the lifeboat are in the safety manual stored in the ship's office. Additional copies are pasted on the inside of the canopy of both lifeboats close to the operating position (**see Figures 1 and 2**). The instructions regarding the release mechanism are as follows:

#### 4.2 Release procedure

- 1) Remove small safety pin (1)
- 2) Raise lever (2) and set socket (3) in place
- 3) Remove safety pin (4) only when you are close to water
- 4) Pull lever to the stopper (7)

#### 4.3 Resetting procedure

- 1) Insert safety pin (4) into pin hole (6)
- 2) Reset hooks to the closed position
- 3) Return lever (2) to the original position
- 4) Remove safety pin (4) and insert into lock hole (5)
- 5 Slide up socket (3) and lower hinged lever (2)
- 6) Set small safety pin (1)

1.4.3 After the accident the MAIB obtained a copy of the "Maintenance and Testing Instructions" from the lifeboat manufacturers in Japan, and found that it included an additional warning notice. This notice states the following:

*If the release mechanism is not re-set properly, this lifeboat will drop. Confirm the following after re-setting the release mechanism.*

*Hooks; Make sure both cam plates are fully returned to their original positions.*

*Release handle: Make sure locking pin is fully inserted into pin hole.*

Below this is a drawing showing the correct position of the cam plate for the hooks, and sectional drawings of both the small safety pin and the locking pin illustrating where the pins should be, **(see Figure 3)**.

These latest guidance notes did not form part of the instructions pasted on the inside of the lifeboat canopies, nor were they seen in the safety manual.

Maintenance records for the lifeboats and their equipment were not available as the previous owners had removed them. Maintenance itself, however, was not considered an issue as all operating equipment seen was in reasonable condition, well greased, and operated as required.

Figure 1

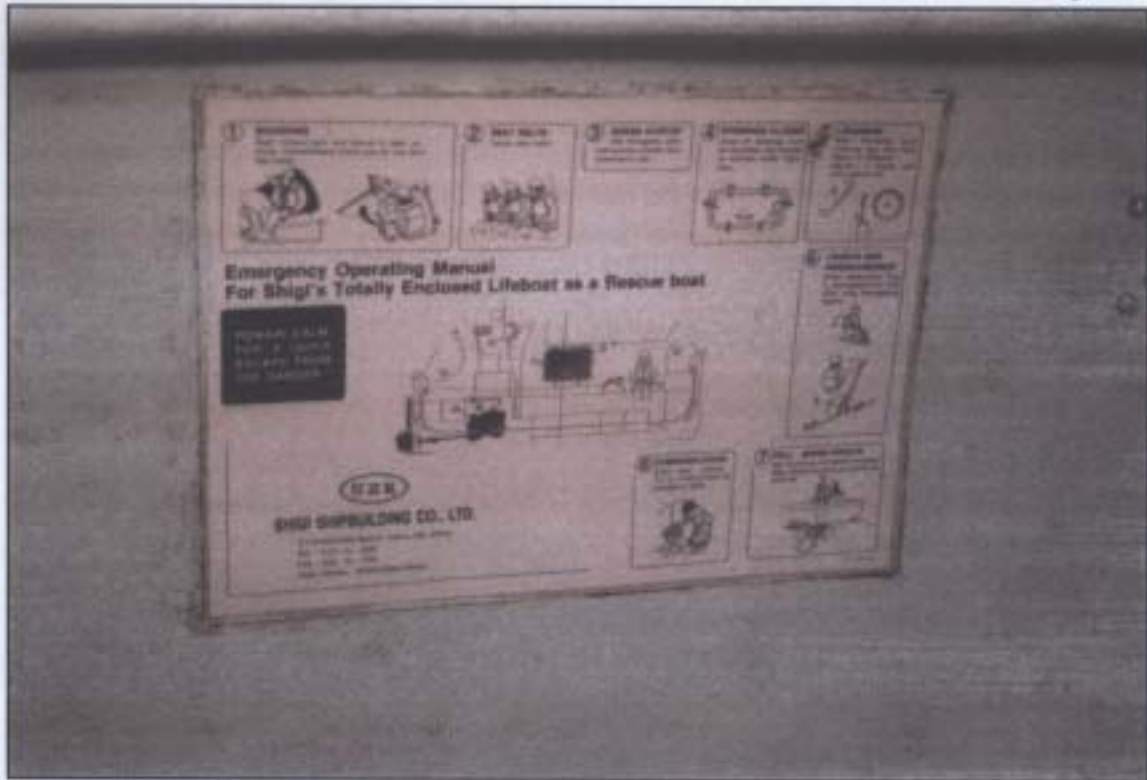

Operating instructions pasted on inside of lifeboat canopy

Figure 2

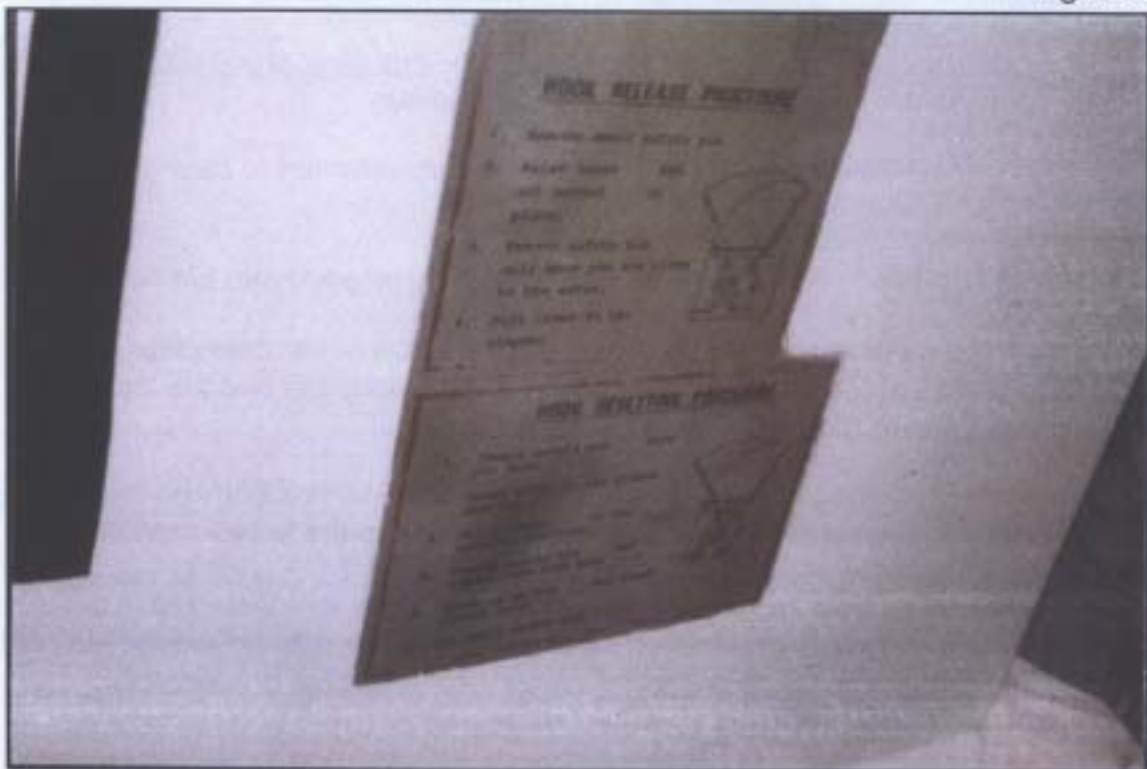

Instructions for operating lifeboat release gear

# WARNING

IF THE RELEASE MECHANISM IS NOT RE-SET PROPERLY, THIS LIFEBOAT WILL DROP. CONFIRM THE FOLLOWING AFTER RE-SETTING THE RELEASE MECHANISM.

HOOKS: MAKE SURE BOTH CAM PLATES ARE FULLY RETURNED TO THEIR ORIGINAL POSITIONS.

RELEASE HANDLE: MAKE SURE LOCKING PIN IS FULLY INSERTED INTO PIN HOLE

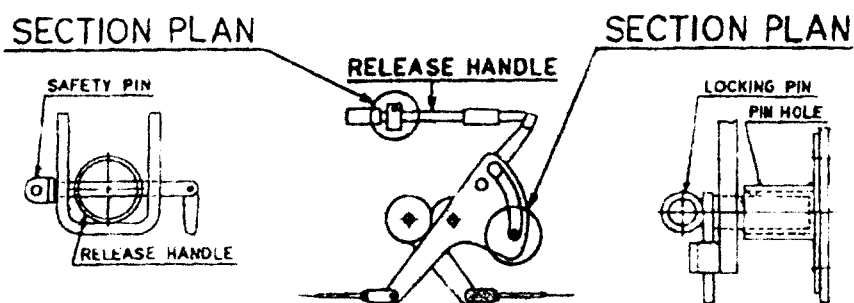
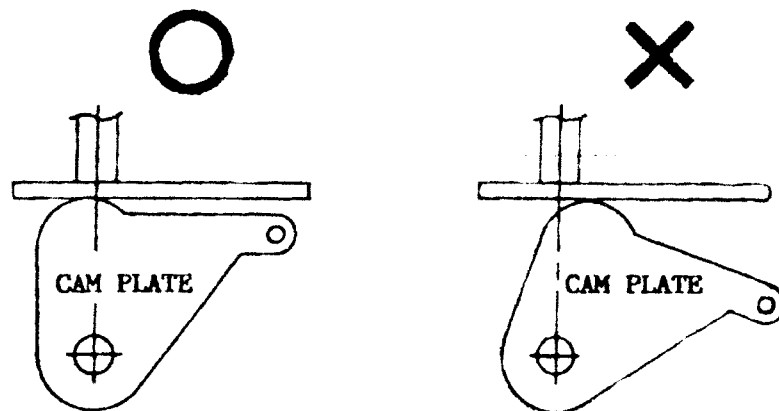

Warning notice **not** issued to vessel until after accident

## 1.5 THE ISM CODE

- 1.5.1 On a change of ownership or flag, there is a requirement under the ISM Code for the new company to demonstrate that its Safety Management System (SMS) meets the objectives under paragraphs 1.2.3 of the Code. An Interim Safety Management Certificate (SMC) may be issued when a company takes on the management of a ship which is new to the company, and is valid for a period of six months.

*Galateia* was in that position at the time of the accident. A surveyor was in the process of carrying out a safety audit, and was inspecting the vessel before issuing an Interim SMC. The conditions necessary for this are:

- The DOC or Interim DOC is relevant to the ship;
- Key elements of the ISM Code have been included in the shipboard SMS and have been assessed during the audit of the company's SMS;
- The master and officers are familiar with the SMS and arrangements for its implementation;
- Instructions, which have been identified as essential, have been provided before sailing;
- There are plans in place for the company to audit the ship within 3 months; and
- The relevant information on the SMS is given in a working language understood by the ship's personnel.

- 1.5.2 The new company's ISM manuals were on board at the time of the audit and it was the surveyor's opinion that, after completing his inspection, the management and crew had complied with, and understood, the requirements of the ISM Code as outlined above.

Therefore, the Interim SMC was issued.

## SECTION 2 - ANALYSIS

### 2.1 AIM

The purpose of the analysis is to determine the contributory causes and circumstances of the accident as a basis for making recommendations to prevent similar accidents occurring in the future.

### 2.2 CAUSE OF INVOLUNTARY RELEASE

- 2.2.1 The primary cause of the simultaneous release of the hooks when at the davit head was the absence of the locking pin in the quadrant (**see Figure 4**) [lock hole (5)].

The locking pin, which is referred to in the release procedure as a safety pin, needs to be fitted in position (5) before the lifeboat is lifted. When in that position, the quadrant is incapable of moving, or being moved, to the release position. On this occasion the safety pin was left in position (6), a position which secures the operating arm to the quadrant. In this position, with the quadrant directly connected to the release mechanism of the hooks, any movement of the operating arm could cause the hooks to open.

When the chief officer reset the release mechanism, he moved the handle into the reset position and then held it there while the lifeboat was being hoisted. By doing so, he prevented the release mechanism from moving into the release position. Once the lifeboat reached the davit head, he stopped holding the handle in position and went to raise the sleeve so that he could fold the handle down. At that point the release mechanism operated and the lifeboat fell away.

- 2.2.2 Why the mechanism should have operated at that point must remain speculation, as even without the locking pin in place, it would require either the quadrant to be moved accidentally, or the cam plate on the hooks not to have been properly in place. As the quadrant needs to be rotated at least 10 cms (and the handle about 15 to 20 cms aft), something which is unlikely to occur when folding the handle, it is probable that the cam plate was not properly home (or in the horizontal position). If the cam plate was in that position, the movement of crew on and around the lifeboat, as well as the movement of the lifeboat when finally being winched home, may well have been sufficient to cause the weight of the lifeboat to exert a downward or release movement of the cam.

As both hooks released simultaneously, it suggests that the reset mechanism had not been pulled right back, thus leaving both cam plates slightly off the horizontal. Nothing would happen while the chief officer was holding the handle, but once he released it, lifeboat/crew movements could cause total release. If only one cam was slightly off the horizontal it is unlikely that both hooks would have released (**see Figures 5, 6 and 7**).

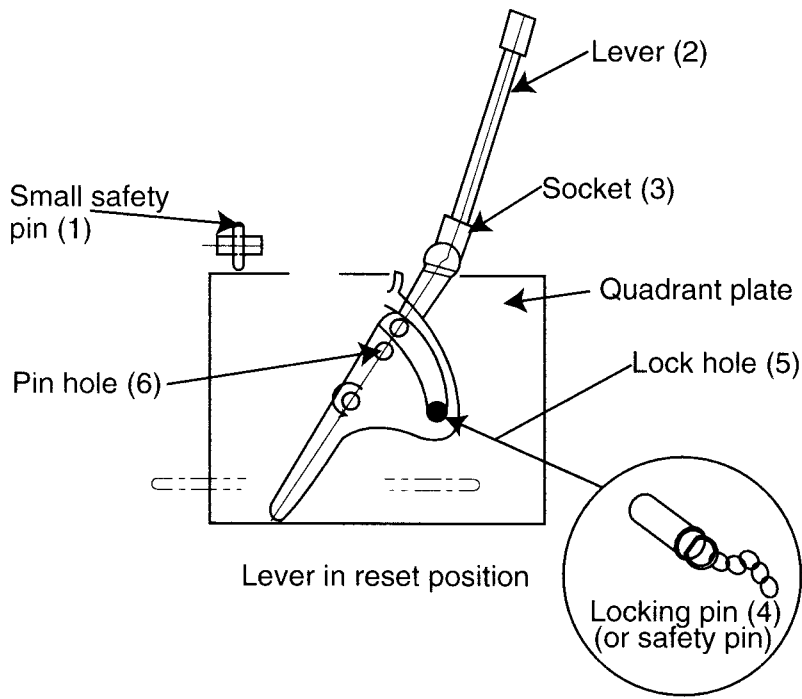

The central operating lever is placed adjacent to the coxswain's position, often in such a fashion that the gearing, quadrant and very important safety pin cannot be viewed easily. Indeed it is often impossible for the user to obtain the same view of the mechanism as it is shown on the instruction panel, he can see it only from above, making the important components difficult to identify. This problem is aggravated by these parts being below the bottom boards of the boat in an area of darkness.

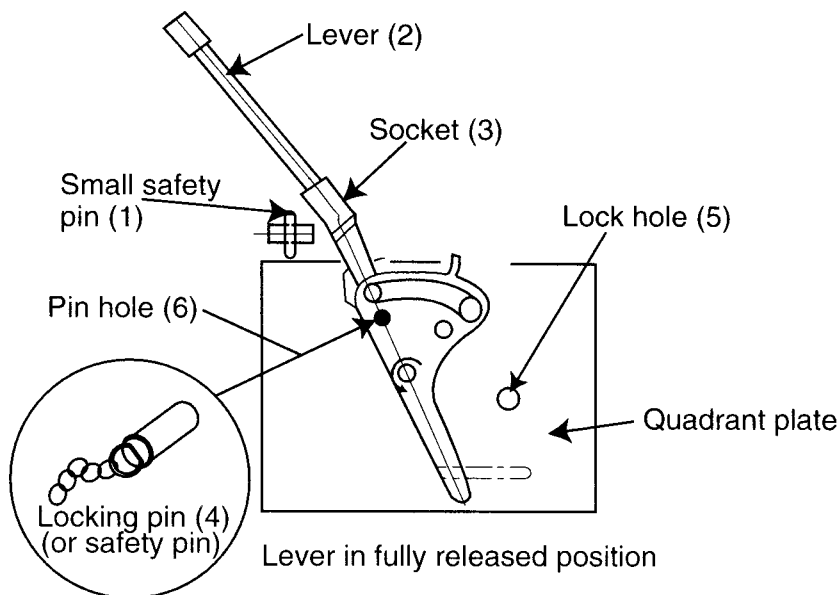

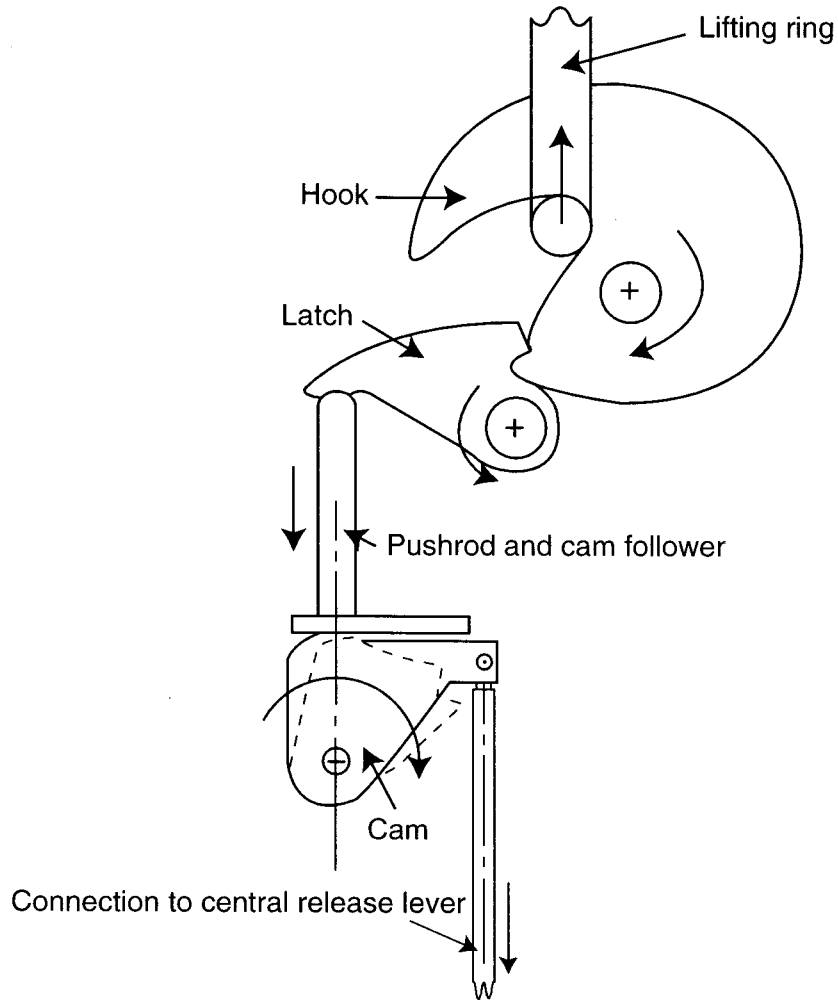

Diagrammatic arrangement of hook release mechanism and the direction of movement of its components during release. Improper resetting of the cam, as shown dotted, can induce an opening moment leading to inadvertent release.

Figure 6

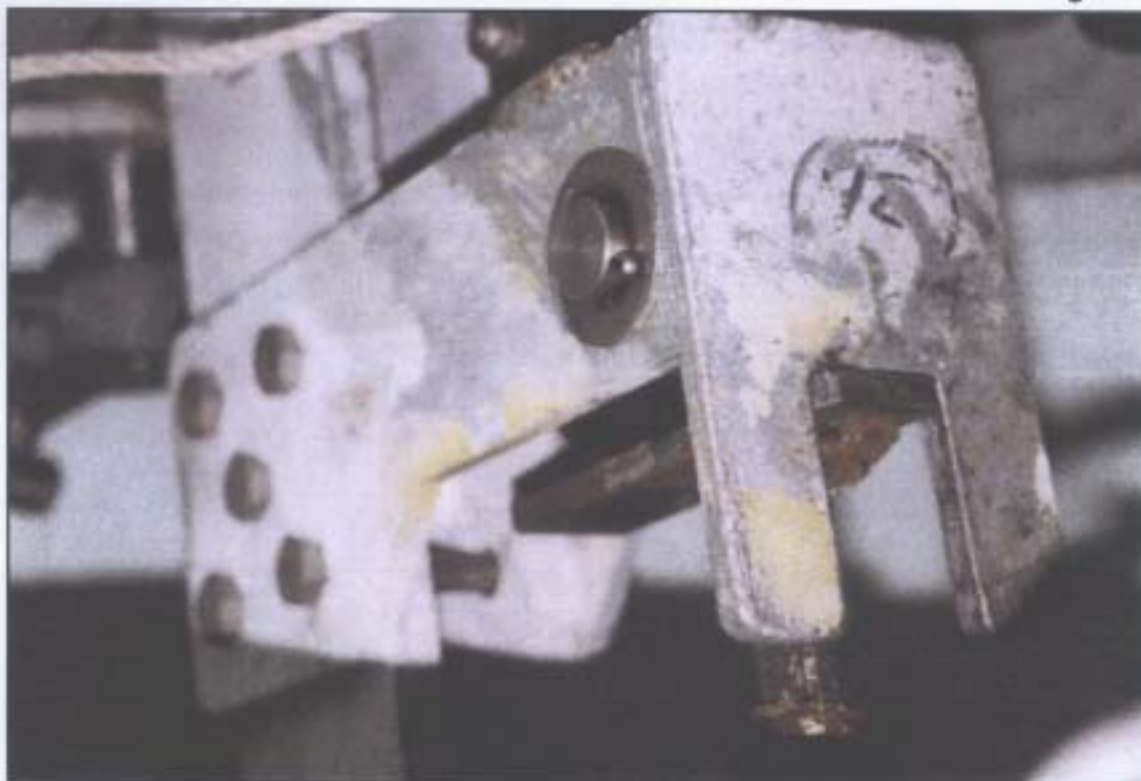

View of hook release gear in locked position

Figure 7



View of hook release gear in open position

## 2.3 INSTRUCTION AND TRAINING

2.3.1 The lifeboat release instructions pasted on the inside of the lifeboat canopy were not very clear, nor were the item numbers clearly legible. In fact, some of the item numbers had completely worn off. As these are critical in identifying the order in which the procedure is to be followed, their loss greatly increased the chances of a mistake being made. The warning notice, which was part of the instructions supplied by the manufacturing company to the MAIB, was not included in the procedural notices pasted on the internal lifeboat canopy. That notice included a pictorial illustration of the correct cam plate position, as well as the correct position of the locking pin before lifting. The lifeboat manufacturers subsequently confirmed that this "Warning" notice was sent out in August 1997 to all users who could be identified. *Galateia's* owners could not be found at that time and, therefore, no notice reached them, hence the omission. That omission has since been rectified and "Warning" notices have been sent to the vessel for inclusion in the safety manual and to be pasted on the inside of the lifeboat canopies.

The master has stated that during the voyage from New Orleans to Liverpool he tried repeatedly to get the original owner's master to show him how the release gear on the lifeboats worked. He was shown briefly the position of the equipment and where the release gear was, but not in any great detail. He, in turn, gave the same information to the chief officer and the rest of the lifeboat crew just before the exercise. What is very clear is that neither the master nor the chief officer was aware of the locking pin (or safety pin), its significance as an essential safety item, nor where and how it should be used. In point of fact, at handover, the locking pins (or safety pins), in both the port and starboard lifeboats, were still in the operating position, something which when viewed for the first time would encourage the chief officer to believe that that was its correct position (see **Figures 8 and 9**).

While waiting for the exercise to start, neither the master nor the chief officer read or studied the instructions and procedures pasted on the lifeboat canopy. Although those instructions were well worn and difficult to understand, it was still possible to see that there was a second small safety pin mentioned in the procedure. That fact alone should have caused them to delve deeper into how the whole operation worked. Unfortunately, they also failed to study the ship's safety manual - this also contained detailed instructions as to how the system was operated and how it worked.

Figure 8



View of release gear with operating handle in stowed position  
Note: Locking pin still in operating position

Figure 9



Close-up view of release gear showing quadrant in reset position **but** locking pin in released position

Correct  
position for  
locking pin

2.3.2 This failure on the part of both the master and the chief officer to study properly the available information on the operation of the release gear put at risk the safety of the lifeboat crew. The master has stated that he did not get a full explanation of how the system worked from the previous crew and, because the chief officer did not tell him that he also was unfamiliar with the system, made the assumption that the chief officer was familiar with it. For the chief officer, he failed to tell the master that he was not familiar with the system and probably made an assumption that the information which the master passed on to him was sufficient for him to work out the correct procedure, based on his previous experience.

Such was the crew's (the previous and the current) lack of knowledge of the system that when the MAIB was shown the undamaged starboard lifeboat, the safety pin was still in the operating handle position and not in the lock position. Fortunately, the lifeboat had been fitted with safety chains.

## 2.4 THE ISM CODE AND CHANGE OF OWNERSHIP/FLAG

The apparent urgency to complete the change of ownership and registry within one or two days of the new crew's arrival does raise questions as to whether the managers had properly considered the risks arising from such an action. The managers, representing the owner, have a responsibility under the ISM Code to provide adequate resources and shore-based support to enable the master to carry out his function. By encouraging him to perform a lifeboat exercise without any prior familiarisation (a five-minute talk with the five crewmen in the lifeboat hardly counts as "familiarisation"), immediately followed by launching, allows no margin of error for those participating. The "lack of adequate resources" considered here is TIME.

The ABS surveyor had attended the vessel on the Thursday before the accident, at the request of the original owners, and had mentioned to the new owners that he was unable to carry out any reflagging surveys until the vessel had actually had a change of ownership. As this was to occur the following day, the same day as the crew change, the surveyor said that it would be unrealistic to carry out any reflagging surveys until the crew had become familiar with the vessel. It was, therefore, arranged that the surveyor would attend on the Saturday morning.

Although there is clearly a responsibility on the master and the chief officer to be familiar with the operation of the lifeboat release gear, both were heavily involved in other matters during the short time between the new crew's arrival and the Saturday morning.

The master had been on board for some 6 or 7 weeks, whereas the chief officer had arrived on the Thursday, 2 days before the accident. At the very least, with a completely new crew, one lifeboat practice should have been programmed in before any official trial. Lifejackets, which are the standard requirement for any lifeboat drill, were not available because of the name change, again indicating that too many changes and drills were being undertaken in too short a time.

The ISM Code under which this vessel was to operate has within it an objective [1.2.2(2)] which requires the company to “establish safeguards against all identified risks”. That means risk assessment should be undertaken for key shipboard operations. Among those operations under *Emergency Preparedness* are programmes for drills and exercise, fire and boat drills, and proper use of emergency equipment. Clearly, in this instance, neither the company nor master and chief officer had considered the implications and risks associated with using unfamiliar equipment. They had general knowledge of lifeboat systems, but not the specific knowledge relating to the equipment fitted to this vessel.

## 2.5 DESIGN OF THE RELEASE GEAR

- 2.5.1 The design of the *Shigi Lifeboat Release Gear* complied with the requirements of Regulation 41, paragraph.7.6, of SOLAS 1974, the 1978 Protocol and the 1981 and 1983 Amendments.

The release control is required to be clearly marked in a high visibility colour, which it was, but no other requirements are identified in these regulations.

- 2.5.2 The revised requirements under the International Life-Saving Appliance Code (LSA Code), IMO Resolution MSC.48 (66) which came into force on 1 July 1998, requires:

*To prevent an accidental release during recovery of the boat, the mechanical protection (interlock) should only engage when the release mechanism is properly and completely re-set. To prevent a premature on-load release, on-load operation of the release mechanism should require a deliberate and sustained action by the operator. The release mechanism shall be so designed that crew members in the lifeboat can clearly observe when the mechanism is properly and completely re-set and ready for lifting. Clear operating instructions should be provided with a suitably worded warning notice.*

The *Shigi Lifeboat Release Gear* fitted to these lifeboats clearly does not satisfy these latest requirements as no mechanical interlock is fitted.

Furthermore, the release gear is positioned low down in the boat on the starboard side next to the control station and below the bottom boards. In this position, the operator is unable to get a clear view of the mechanism, or see the position of the locking pin. At night, without a torch, it would be impossible - it would have to be done by touch. Under emergency conditions this is not acceptable. With the operating mechanism in this position, access is difficult not only for visibility but also for maintenance. It is possible, however, for the crew to sight the operation of the hook mechanism at each end of the boat, and to check that the cam plate is in the correct horizontal position before hoisting.

In respect of the lifeboat crew's ability to observe clearly the mechanism, this release gear would not be accepted under the revised regulations.

## **2.6 PORT AUTHORITY'S REPORTING PROCEDURES**

During the course of the investigation, it became apparent that when the accident happened, the vessel reported it to the duty dockmaster and not, as would normally be expected, direct to Mersey Radio (VTS).

The Port Authority (The Mersey Docks and Harbour Company), issue guidance notices for ships arriving at the port and has, up to now, never needed to spell out the requirement to call VTS in the event of an accident. Its guidance notice in the case of a fire includes procedural instructions which require the vessel to call the authorities using either VTS or to make a 999-telephone call. These guidance notes, however, do not refer to accidents in general. That omission is to be rectified, and the Port Authority will in future include a requirement in its handout to report all accidents to Mersey Radio (VTS).

## **2.7 ACCIDENT RESPONSE**

2.7.1 This accident has also raised a question as to the extent and capability of the Port Authority to respond quickly to "in water" emergencies. With many vessels having only one lifeboat per side, any incident which immobilises the lifeboat's seaward side leaves the vessel unable to undertake any rescue action either for herself or any other vessel in the vicinity. (Any FRC boat carried may also not be available if it is stowed on the "seaward" side or "landward" side.) In these circumstances the vessel becomes totally reliant on either the Port Authority or adjacent vessels for assistance.

In this case, although notified soon after the accident and despite a rapid response, it was some 10 minutes before the Port Authority's tug arrived on scene to assist in the rescue. This was followed, a few minutes later, by a launch. The tug with its high freeboard and design could offer limited assistance, and it was only when the launch arrived that the Authority was in a position to provide close support and assistance.

2.7.2 Fortunately, with the lifeboat still attached to the vessel by head ropes and alongside, a rope ladder was thrown over the side and other crew members were able to climb down and assist. That assistance, limited as it was, was critical in preventing the situation deteriorating further. The accident illustrated that without access to a small watercraft, the injured people could only be comforted, but not recovered. If the accident had resulted in injuries requiring immediate treatment and swift evacuation, the current availability of rescue craft within the docks could not provide an adequate response.

Given this incident and the circumstances of the time delay, the Port Authority may wish to consider having a safety boat readily available to offer immediate help and assistance. This safety boat could take the form of a RIB, which could provide a rapid response, and be small enough to enable people to be rescued from the water. The operation of such a craft could form part of the emergency response team of the Authority as well as providing a waterborne vehicle for use as a security asset.

## **2.8 MAINTENANCE RECORDS AND THE ISM CODE**

One aspect of the change of ownership that is not conducive to safety, and does not reflect the philosophy behind the introduction of the ISM Code, is the tendency for some owners at the time of sale to remove all maintenance records from the vessel. While it would be understandable for owners to remove records relating to their purchasing policy and costs, the value to them, of maintenance records for ships no longer part of their fleet, is questionable. However, their value to the new owners, in establishing what needs to be done and when, is a critical part of the safety of the vessel and her crew.

The general practice in the aeronautical industry is for maintenance records to remain with the aircraft no matter how many times it might change ownership. This allows new owners to plan the continued maintenance of the aircraft, such that it retains its airworthiness certificate. In a similar vein, there seems no good reason why a vessel, on change of ownership, should not also retain its maintenance records. Such a requirement could form part of the ISM Code in ensuring that vessels continue to be maintained in a safe and efficient state for the benefit of both owners and crew. The ISM Code is currently being implemented on a worldwide basis, and IMO might well consider the retention of maintenance records on vessels as a useful step in assisting owners to maintain safe and efficient vessels.

## **2.9 PREVIOUS INVESTIGATIONS BY THE MAIB**

Previous investigations of accidents involving this type and manufacture of lifeboat release gear have highlighted the difficulty which crews have in obtaining a clear view of the mechanism. Not having a clear view is a contravention of current legislation.

## **SECTION 3 - CONCLUSIONS**

### **3.1 CAUSE AND CONTRIBUTING FACTORS**

1. The primary cause of the simultaneous release of the hooks when at the davit head, was the absence of the locking pin in the quadrant [lock hole (5)]. (2.2.1)
2. The release gear operated when the lifeboat was at the davit head, probably because the boat moved on the hooks because the cam plates were not fully home in the horizontal position. (2.2.2)
3. Before starting the exercise, neither the master nor the chief officer had studied the vessel's safety manual or the operational instructions pasted on the inside of the lifeboat. (2.3.1)
4. Neither the master nor chief officer was aware that there was a safety pin fitted to prevent involuntary release. (2.3.1)

### **3.2 OTHER FINDINGS**

1. A pictorial and explicit warning notice issued by *Shigi Shipbuilding Co, Japan* with subsequent versions of the release gear had not been supplied to the vessel by the manufacturer. (2.3.1)
2. The operating instructions pasted on the inside of the lifeboat canopy were in a poor state, with some item numbers worn and illegible. (2.3.1)
3. Both the damaged port lifeboat, and the starboard lifeboat, were left by the previous crew in a dangerous state - the locking pin had been left in the operating handle. Fortunately the starboard lifeboat had been secured using safety chains. (2.3.2)
4. The new owners and/or managers did not allow sufficient time for the crew to familiarise themselves with the vessel and equipment before starting exercises, as required under the ISM Code. (2.4)
5. The design of the release gear on these lifeboats complied with the SOLAS requirements in force at the time of their construction - 1993.
6. Under the revised SOLAS requirements which came into force in July 1998, the release mechanism must be fitted with an interlock, and the operation of the mechanism must be clearly visible to the lifeboat crew. (2.5)
7. Since *Galateia* failed to report the accident via VTS, the Port Authority has amended its port instructions, so that in the future all accidents must be reported direct to VTS. (2.6)
8. The Port Authority's capability to respond to "in water" accidents is limited by the type of boat available, the time taken to mobilise, its manoeuvrability, and its ability to cope with life-threatening situations. (2.7.1)

## **SECTION 4 - RECOMMENDATIONS**

**Angrian Enterprises Ltd, as owners, and E Nomikos Corporation, as managers,** are recommended to:

1. Ensure that copies of all operating instructions and warning notices issued by *Shigi Shipbuilding Co, Japan* are clearly legible and pasted on the inside of the canopy of each lifeboat.
2. Ensure that all officers and crew members involved in the operation of the lifeboats are fully instructed on the release mechanism, the function and position of each safety pin, and the correct procedure to be followed.

**The International Maritime Organization (IMO), through the Maritime and Coastguard Agency** is recommended to:

3. Include in the ISM Code, a requirement that all records and notes relating to the condition and maintenance of the equipment and machinery remain on board a vessel at the time of her sale to new owners, as an aid in maintaining a safe and efficient vessel.

**Marine Accident Investigation Branch  
July 2002**

**General Photographs**

Figure 10



General view of inside starboard lifeboat showing difficult access to operating gear

Figure 11



Small  
"safety"  
pin

View of operating handle in stowed position

Figure 12



Moveable  
sleeve

General view of access to release gear

Figure 13



General view of stern hook mechanism



Figure 14 - Damage to hull due to striking deck equipment during fall





Copy of original lifeboat release gear instructions issued to vessel as part of the delivery documentation, August 1993.

PLAN RECORD

H4.4-16

日立S.No. 4867/4868 何工承認申請  
図として作成する。

H5.8-18

S.No. 4867 完成図用として調整する。

# M.V. GORTYS

HITACHI ZOSEN

S.NO. 4867

MODEL NO: SZ-65BR

(JG TYPE APPROVED NO. 3308)

**FRP  
TOTALLY  
ENCLOSED LIFEBOAT**

6.50M X 2.60M X 1.10M

**FINISHED PLAN**

**SHIGI SHIPBUILDING CO., LTD.**  
OSAKA, JAPAN.

DESIGNING SECTION  
TECHNICAL DEPARTMENT

CHIEF OF DEPT. *H. Maruyama*

CHIEF OF SECT. *T. Yamaguchi*

CHECKED BY. *E. Okada*

DRAWN BY. *M. Takamura*

DATE AUG. 19. 1993

WORK NO. 16136-7

DRAWING NO. T-3253

REV.



完成図

配布先

注文主 5

船主

JG

NK

LR

AB

BV

NV

営業

船設1

船設2

検査

機設

電設

現図

船殼

鉄鋼

木質

機組

塗装

運輸

倉庫

外注

控 1

合計 6

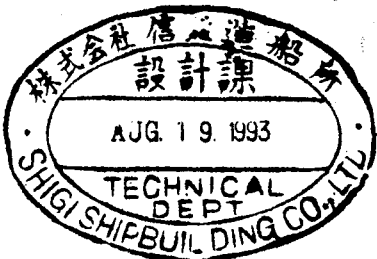
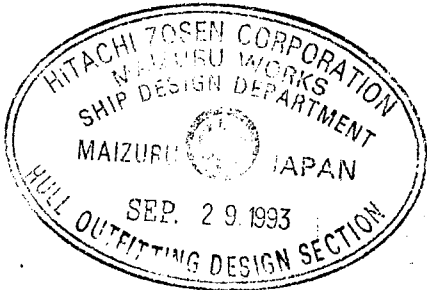

SHEET No. F210-201

37 SHEETS WITH COVER

*dep's set*

*Prop*

SHIGI SHIPBUILDING CO., LTD.

*3/7*

F3

#### 4. RELEASING DEVICE

This lifeboat is equipped with an on/off-load type "SHIGI release gear". It can be release the lifeboat under any condition of loading from no-load with the lifeboat water-borne to a load of 1.1 time the full load condition of the lifeboat.

##### 4.1 Launching and releasing operation

Pull the remote control wire, drawn into the side of the helmsman's seat, at a force of about 20 kg; the boat will start lowering at a specified speed.

- ※ This hook release device is capable of releasing the boat from the falls at any height, on or above sea level. Exercise extreme caution to avoid accidental or premature release.

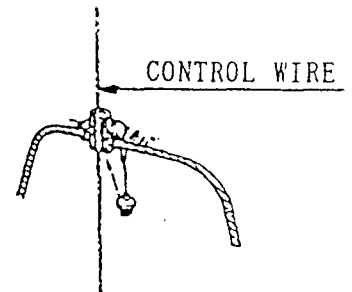

##### 4.2 Release procedure

- 1) Remove small safety pin ①.
- 2) Raise lever ② and set socket ③ in place.
- 3) Remove safety pin ④. only when you are close to the water.
- 4) Pull lever to the stopper ⑦.

RELEASE PROCEDURE

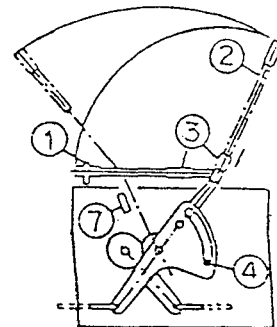

##### 4.3 Resetting procedure

- 1) Insert safety pin ④ into pin hole ⑥.
- 2) Reset hooks to the closed position.
- 3) Return lever ② to the original position.
- 4) Remove safety pin ④ and insert into lock hole ⑤.
- 5) Slide up socket ③ and lower hinged lever ②.
- 6) Set small safety pin ①.

RESETTING PROCEDURE

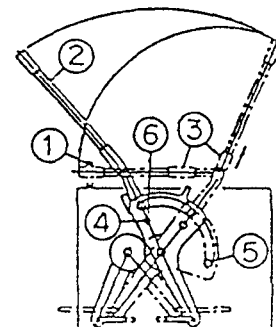

Note: The shackling hole top the side plate are equipped with an extra in order to adjust of hook head on board the ship. This shackling hole is designed only to hold an empty boat must not to used for other purposes.

Copy of Release Gear Safety Instructions issued to all owners  
by *Shigi Shipbuilding Co Ltd* on 28 August 1997.



# SHIGI SHIPBUILDING CO., LTD.

2-1 ISHIZUNISHI-MACHI, SAKAI, OSAKA, JAPAN. 592

CABLE ADDRESS:  
SHIGIZOSEN OSAKA

PHONE: 0722(41)2033  
FAX: 0722(44)1728

**COPY**

To: TOKYO TANKER CO., LTD.  
Attn: Superintendent

Subject : Release gear  
Your ref:  
Our ref : 97-LB0828  
Date : August 28, 1997

Dear Sir:

We are the manufacturer of the lifeboats (model SZ-65TR) installed on board the subject vessel(s). We are writing this letter to advise you of the following with regard to the release gear system of the vessel(s). and would appreciate it if you would read them.

1. A lifeboat of this model of some vessel recently fell off from the davit during a routine drill by the crew. Incomplete re-setting of the release gear of that lifeboat was found to be the a probable cause.
2. In order to prevent the similar accident from occurring, the following advice is given:
  - 2-1 If proper maintenance and inspection procedures are not carried out by crew for the release gear of lifeboat of this model, the moving parts of the release cables (Att. No. 01) might stick.
  - 2-2 The release gear of which cables stick may not be re-set correctly and completely, even if the release handle has been returned to the re-set position during a routine drill. It is highly dangerous to recover or lower the lifeboat with its release gear not re-set correctly and completely, as this may lead to an accident.
  - 2-3 Accordingly, proper maintenance and inspection for the lifeboats of this model, especially the release gears must be carried out by crew regularly and thoroughly. Above all, it is essential that crew members must ensure that the release gears are correctly and completely re-set after every drill, before the boats are restored in the davit.

**SHIGI SHIPBUILDING CO., LTD.**  
OSAKA, JAPAN.

No. ....

3. The present condition(s) of the lifeboat release cables of the subject vessel(s) should be inspected. If the cables are considered to stick, they must be renewed. Renewal can be made by the crew members on board the vessel(s). If requested by you, we will provide you with new cables, together with instructions necessary for renewal at a reasonable cost.

4. We enclose herewith the following documents etc. regarding the release gears of the vessel(s). Please make them available to your crew:

4-1 Stickers

- Danger Sign including Hook Release Procedure\*
- Re-setting Procedure\*
- Check Points and Caution for re-setting procedure

Although the stickers marked with an asterisk \* were supplied when the boats were first delivered, we are providing you with spares in case the original stickers become faded or difficult to read.

4-2 Maintenance and Testing Instructions (Att. No. 02)

Although maintenance and testing instructions were given in the drawings supplied with the boat upon delivery, we are providing instructions that your crews will easy to understand

# DANGER

THIS HOOK RELEASE DEVICE IS CAPABLE OF RELEASING THE BOAT FROM THE FALLS AT ANY HEIGHT, ON OR ABOVE SEA LEVEL.

EXERCISE EXTREME CAUTION TO AVOID ACCIDENTAL OR PREMATURE RELEASE.

## HOOK RELEASE PROCEDURE

1. Remove small safety pin ①.
2. Raise lever ② and set socket ③ in place.
3. Remove safety pin ④ only when you are close to the water.
4. Pull lever to the stopper ⑦.

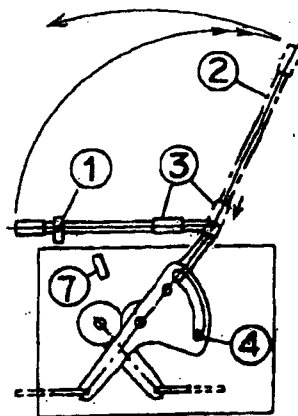

## HOOK RESETTING PROCEDURE

1. Insert safety pin ④ into pin hole ⑥.
2. Reset hooks to the closed position.
3. Return lever ② to the original position.
4. Remove safety pin ④ and insert into lock hole ⑤.
5. Slide up socket ③ and lower hinged lever ②.
6. Set small safety pin ①.

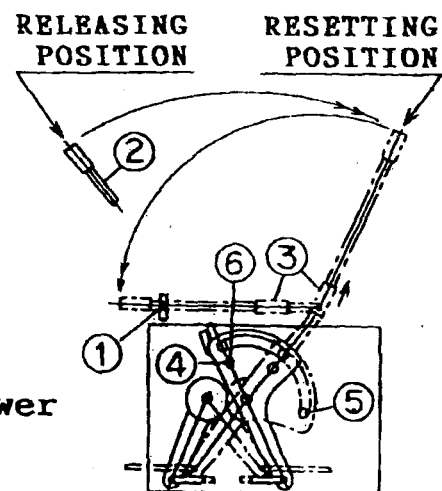

# WARNING

IF THE RELEASE MECHANISM IS NOT RE-SET PROPERLY, THIS LIFEBOAT WILL DROP. CONFIRM THE FOLLOWING AFTER RE-SETTING THE RELEASE MECHANISM.

**HOOKS:** MAKE SURE BOTH CAM PLATES ARE FULLY RETURNED TO THEIR ORIGINAL POSITIONS:

**RELEASE HANDLE:** MAKE SURE LOCKING PIN IS FULLY INSERTED INTO PIN HOLE

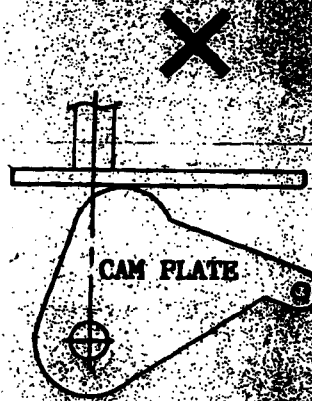
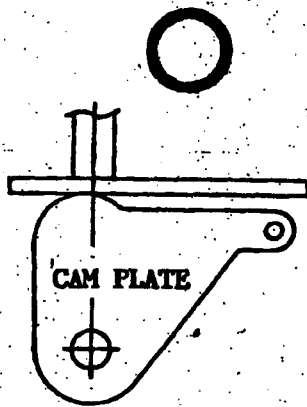

SECTION PLAN

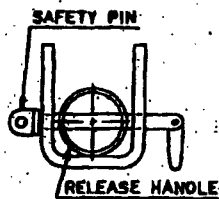

RELEASE HANDLE

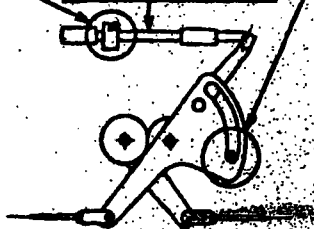

SECTION PLAN

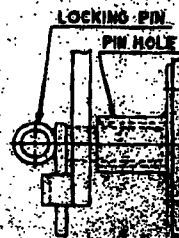

MAINTENANCE AND TESTING INSTRUCTIONS  
FOR  
LIFEBOAT RELEASE GEAR  
WITHOUT INTER-LOCK SYSTEM  
( HOOK MODEL : SZK-5 )

FOR LIFEBOAT MODELS:

SZ-65TR/65BR

SZ-73TR/73BR

SZ-80TR/80BR

SHIGI SHIPBUILDING CO., LTD.

6 SHEETS WITH COVER

SZK-5/1

This manual gives instructions for the maintenance and testing of the traditional hook release mechanism employed in Shigi Shipbuilding Co.'s lifeboat/rescue boat models.

This hook release mechanism is used for the lowering, launching, release and recovery of the lifeboats, and fully satisfies the requirements of SOLAS III Reg. 41.7.6.

A tensile strength test and release capabilities test were conducted on the mechanism in accordance with IMO Res. A521(13) para. 6.10, before being mounted on the prototype boat of each lifeboat model. The release mechanism on every production boat was tested in accordance with IMO Res. A521(13) part 2, para. 5.3.1 to confirm its capabilities.

#### 1. Maintenance Instructions (SOLAS III Reg. 52)

For onboard maintenance, link the maintenance pendant holes at the tops of the hooks to the davit cradle using pendant lines. Make sure that there is no weight on the release hooks or release mechanism. Next, the helmsman and designated maintenance crew should perform the following procedure.

- 1) Open both fore and aft access hatches and bind them so they remain open.
  - 2) Visually check the condition of the release gear system.
  - 3) Simulate Release as follows.
    - a. Remove small safety pin (1).
    - b. Raise handle (2) and set socket (3) in place.
    - c. Remove safety pin (4).
    - d. Pull handle to the stopper (5).
    - e. Release mechanism will begin operating, and hook tails will be disconnected from No.1 hook bearers.
    - f. Hooks will rotate and disengage automatically from the long links.
- \* Make sure the hooks and other parts move smoothly throughout the above procedure.
- 4) At the intervals given in the maintenance program, inject high-quality water-repellent grease into the two grease nipples of the No.2 hook bearers.
  - 5) There is no need to lubricate the release teleflex cables onboard, as they have already been lubricated before installation on the lifeboat.  
If there is any problem with the cables, contact Shigi Shipbuilding immediately.

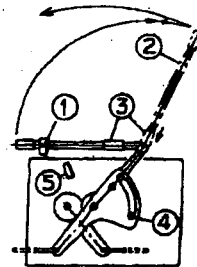

- 6) Make sure the Instruction poster and Caution Notice for the hook release mechanism are clear and legible. If they are hard to read, contact Shigi Shipbuilding immediately.
  - 7) Re-set the release mechanism according to the re-setting instructions given below.
2. Re-setting Instructions
- a. Insert safety pin into recovery hole (6).
  - b. Manually return both fore and aft hooks to closed position.
  - c. Return release handle to its original position.
  - d. Remove safety pin from recovery hole and insert it into locking hole.
  - e. Raise socket, and fold down release handle.
  - f. Insert small safety pin to hold handle in place.
  - g. Manually engage links under both hooks.
3. Testing Instructions (SOLAS III Reg. 18 & 52)
- Abandon Ship Training and Drills must be conducted in accordance with the regulations. The helmsman and designated testing crew should perform launching, release and recovery of the lifeboat according to the following procedure.
- 1) Remove the davit cradle stoppers and lashing wires.
  - 2) Helmsman and testing crew board the lifeboat and fasten their seat belts.
  - 3) The last person to board reconfirms that the launching area is clear.
  - 4) Close embarkation hatch and all access hatches.
  - 5) Pull the control wire of the davit winch to lift the brake and lower the lifeboat to the water.
  - 6) When the lifeboat is in the water:  
Operate the Normal Release (off-load) procedure by following the instructions on the Instruction Plate, and make sure that the lifting hooks are disengaged from the boat falls.
  - 7) Test the other equipment while at sea in accordance with the regulations.
  - 8) Engage the hooks to the boat falls and reset the system.
  - 9) If necessary:  
Lift the boat about 30cm above the water, and perform the release test once more, using the above Release (on-load) procedure, in accordance with the same Instruction plate.
  - 10) Totally reset the system according to the hook resetting instructions.
  - 11) Stow the lifeboat in the davit.